

# LoCa® 广州龙创电子科技有限公司

Guangzhou LongChuang Electronic Technology Co., Ltd

地址: 广州市番禺区洛浦街东乡村民安路8号3号楼五层

Add:5th,3rd building,Minan road NO.8,Dongxiang village,Luopu street,Panyu,Guangzhou

电话(Tel): 0086-020-34890057 Email:sales04@gzclcd.com Contact:Lillian Xu(+86 18675956820)

网址(Web):www.gzclcd.com

## 防水型铝壳恒压电源(IP67 Waterproof Aluminum Shell Constant Voltage Power Supply)200W



### 产品特点(Features):

1. 恒定电压输出(Constant Voltage design).
2. 输入电压(AC input Voltage range)175-265Vac.
3. 保护功能:短路保护/过载保护/过压保护均可自恢复。  
(Protections:Short circuit/Over load/Over current/Over Voltage)
4. 常温自冷(Cooling by Convection or Forced air)
5. 100% 满载老化(100% full load burn-in test)
6. 高可靠性(High Reliability)
7. IP67防水等级(IP67 waterproof grade)

规格	SPECIFICATION	F-200-12	F-200-24
输出 OUTPUT	输出电压 Rated DC voltage	12V±0.5V	24V±0.5V
	电流范围 Current range	0-16.6A	0-8.3A
	额定功率 Rated Power	200W	
	纹波及噪声 Ripple & Noise	≅ 120mVp-p	≅ 240mVp-p
	输出上升时间 Setup,Rise time	50ms/230VAC	
	输出保持时间 Hold up time	20ms/230VAC	
输入 INPUT	输入电压范围 Voltage range	AC90-130V/AC180-240V	
	频率 Frequency range	50-60HZ	
	效率 Efficiency(Tpy.)	≅ 84%	≅ 86%
	功率因素 Power factor	0.65(max)	
	漏电流 Leakage current	0.25mA/230VAC	
保护 PROTECTION	过流保护 Over Current	105%-130% 保护类型: 打嗝式保护/自恢复 Protection type: Hiccup mode	
	短路保护 Reset After Shutdown	短路保护: 自恢复 after the fault has been removed	
使用环境 ENVIRONMENT	工作温度 Working TEMP.	-40℃-45℃	
	存储温度 Storage TEMP.	-40℃-80℃	
	相对湿度 Working Humidity	0--100%	
	振动 Vibration	10-500HZ,2G 10min/1cycle,preiod for 60min,each along X,Y,Z axes	
	温度系数 TEMP. coefficient	±0.03%℃ (0-50℃)	

安规及电磁兼容 SAFETY&EMC	安全标准 Safety Standards	Design refer to LVD EN61347-2-13:2006,EN61347-1:2008
	耐压 With stand Voltage	I/P-O/P:2.5KVAC,I/P-COVER:2.5KVAC,O/P-COVER:500VAC
	绝缘电阻 Isolation Resistance	I/P-O/P:>100M Ohms/500VDC/25°C/70% RH
其它 OTHERS	寿命 MTBF	50KHours (25°C)
	尺寸 Dimension	215.4*68*36mm(L*W*H)不含线 (Without line)
	重量 Weight	870g

安装尺寸(单位:mm)

Configuration dimensions(Unit:mm)

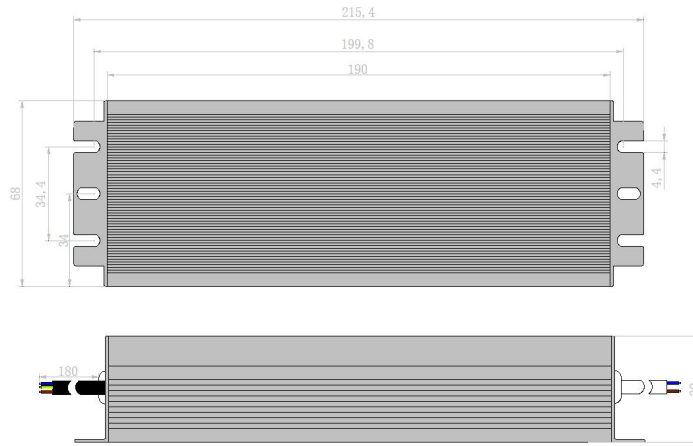

组成结构图:

Circuit diagram:

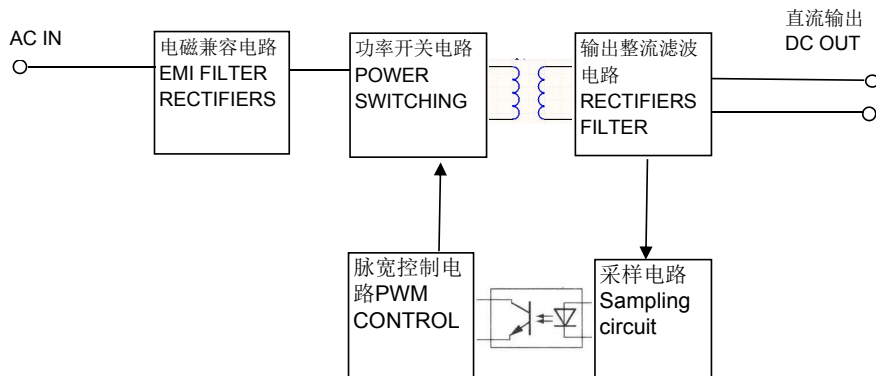

带载曲线

Diagram:

