



广州龙创电子科技有限公司

Guangzhou LongChuang Electronic Technology Co., Ltd

地址: 广州市番禺区洛浦街东乡村民安路8号3号楼五层

Add:5th,3rd building,Minan road NO.8,Dongxiang village,Luopu street,Panyu,Guangzhou

电话(Tel): 0086-020-34890057 Email:sales04@gzclcd.com Contact:Lillian Xu(+86 18675956820)

网址(Web):www.gzclcd.com

经典款恒压电源(Classic constant voltage power supply) C-250



产品特点(Features):

- 1.恒定电压输出(Constant Voltage design).
- 2.输入电压(AC input Voltage range)175-265Vac.
- 3.保护功能:短路保护/过载保护/过压保护均可自恢复。
(Protections:Short circuit/Over load/Over current/Over Voltage)
- 4.100% 满载老化(100% full load burn-in test)
- 5.高可靠性(High Reliability)



规格	SPECIFICATION	C-250-12	C-250-24
输出 OUTPUT	输出电压 Rated DC voltage	12V±0.5V	24V±0.5V
	电流范围 Current range	0-20.83A	0-10.41A
	额定功率 Rated Power	250W	250W
	纹波及噪声 Ripple & Noise	≤120mVp-p	≤240mVp-p
	输出上升时间 Setup,Rise time	50ms/230VAC	
	输出保持时间 Hold up time	20ms/230VAC	
输入 INPUT	输入电压范围 Voltage range	AC175-265V	
	频率 Frequency range	47 ~ 63HZ	
	效率 Efficiency(Tpy.)	≥ 83%	≥85%
	功率因素 Power factor	0.6	
	漏电流 Leakage current	0.25mA/230VAC	
保护 PROTECTION	过流保护 Over Current	105%-130%	
	短路保护 Reset After Shutdown	保护类型: 打嗝式保护/自恢复 Protection type: Hiccup mode 短路保护 : 自恢复 after the fault has been removed	
使用环境 ENVIRONMENT	工作温度 Working TEMP.	-25°C-45°C	
	存储温度 Storage TEMP.	-40°C-80°C	
	相对湿度 Working Humidity	0-95% (无凝露No condensation)	
	振动 Vibration	10-500HZ,2G 10min/1cycle,preiod for 60min,each along X,Y,Z axes	
	温度系数 TEMP. coefficient	±0.03%/°C (0-50°C)	
安规及电磁兼容 SAFETY&EMC	安全标准 Safety Standards	Design refer to LVD EN61347-2-13:2006,EN61347-1:2008	
	耐压 With stand Voltage	I/P-O/P:3KVAC,I/P-COVER:3KVAC,O/P-COVER:500VAC	
	绝缘电阻 Isolation Resistance	I/P-O/P:>100M Ohms/500VDC/25°C/70% RH	
	电磁兼容 EMC	EN55015:2006/A2:2009,EN61000-3-2:2006/A2:2009,EN61000-3-3:2008,EN61547:2009	

其它 OTHERS	寿命 MTBF	50KHours (25°C)
	尺寸 Dimension	200*110*50mm(L*W*H)
	重量 Weight	850g

安装尺寸(单位:mm) Configuration dimensions(Unit:mm)

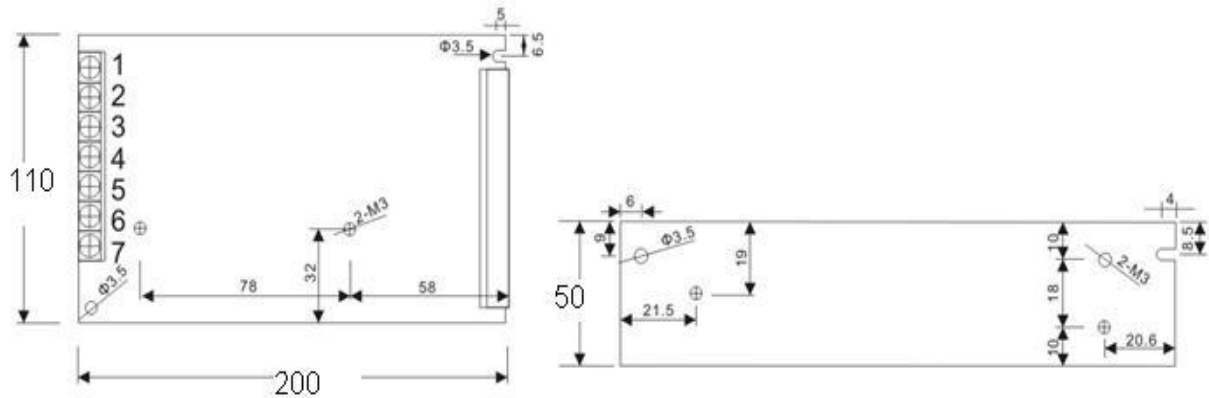

组成结构图: Circuit diagram:

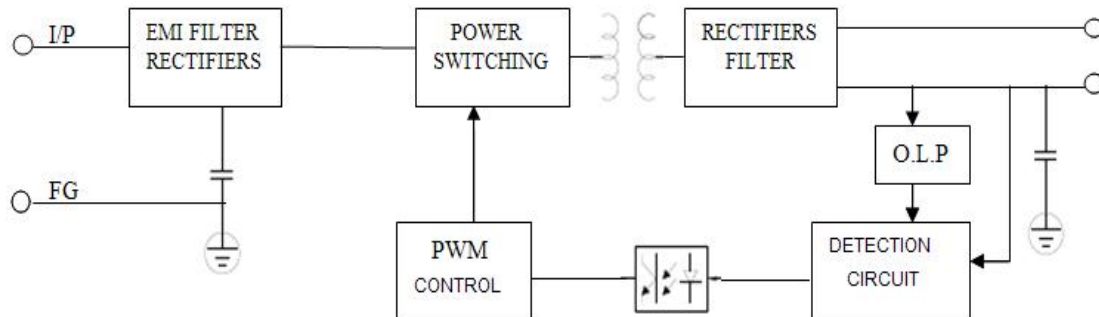

带载曲线 Diagram:

